

VIGOUR

VIGOUR GmbH - Bergholzstraße 3 - 12099 Berlin

DEPBSTVCH (176 90 00)

derby basic plus

Waschtisch Selbstschluss-Standventil

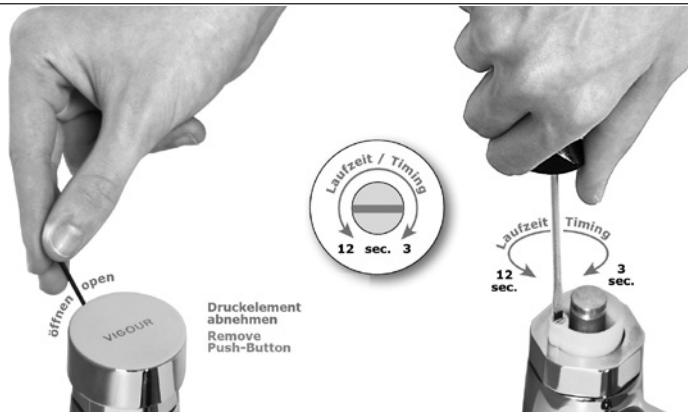
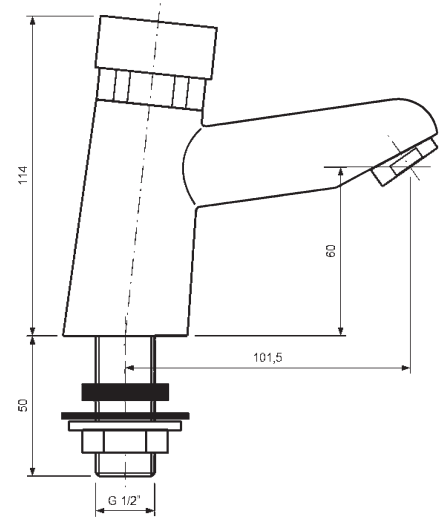

Druckknopf lösen, mit Inbus-Schlüssel 2 mm

Laufzeit einstellen

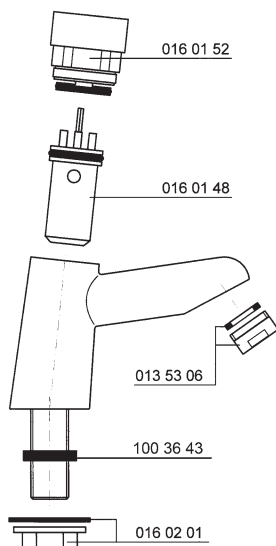

DEPBSTVCH

Wichtige Ersatzteile

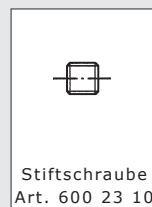
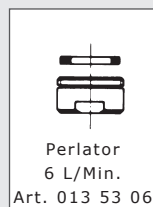

VIGOUR

VIGOUR GmbH - Bergholzstraße 3 - 12099 Berlin

Montagevorbereitung

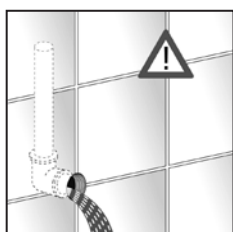

Wasserleitung
spülen

Befestigung

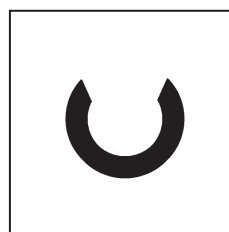

Zentrierung für handelsübliche Keramikbecken
sorgt für optimale Befestigung

Pflege

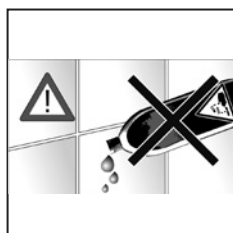

Keine aggressiven
Reinigungsmittel verwenden

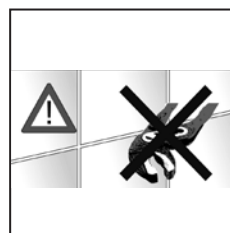

Keine Rohrzange
verwenden

Wartung

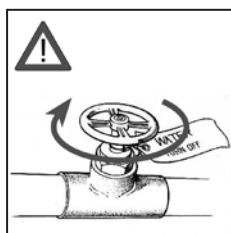

Wasserhauptahn
absperren

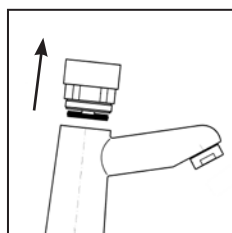

Druckknopf lösen

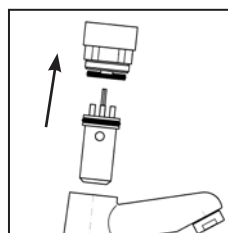

Druckknopf und
Kartusche mit Kolben,
Feder, Sitz entnehmen

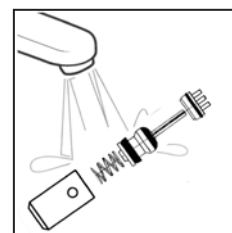

Bei zu langer Laufzeit:
Kartusche innen mit
Leitungswasser ausspülen